



1N4148WS SURFACE MOUNT SWITCHING DIODE

Rev.2.5

FEATURE

- ◇ Fast Switching Speed
- ◇ Surface Mount Package Ideally Suited for Automatic Insertion
- ◇ For Surface Mounted Applications
- ◇ RoHS Compliant/Green EMC
- ◇ For General Purpose Switching Applications
- ◇ High Conductance

MECHANICAL DATA

- ◇ Case: SOD-323, Plastic
- ◇ Polarity: Cathode Band
- ◇ Type Code: T4

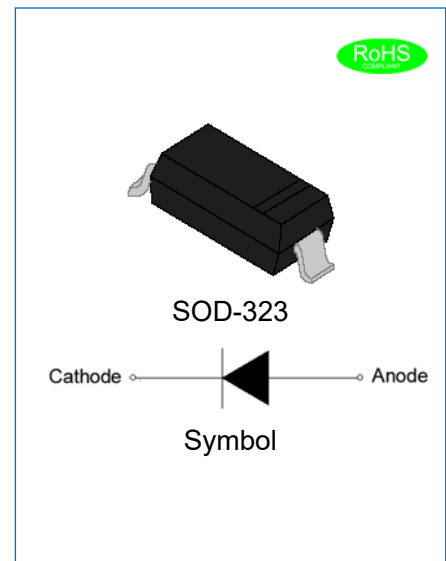

ABSOLUTE MAXIMUM RATING CHARACTERISTICS

(Rating at 25°C ambient temperature unless otherwise specified.)

Parameter	Symbol	1N4148WS	Unit
Continuous Reverse Voltage	V_R	75	V
Peak Repetitive Reverse Voltage	V_{RM}	100	V
Average Rectified Output Current	I_O	150	mA
Forward Continuous Current	I_{FM}	300	mA
Non-repetitive Peak Forward Surge Current ($t_P=1\mu s$)	I_{FSM}	2	A
Power Dissipation at $T_A=25^\circ C$	P_D	200	mW
Thermal Resistance (Junction to Ambient)	$R_{\theta JA}$	625	$^\circ C/W$
Operating Junction Temperature Range	T_j	-55 to +150	$^\circ C$
Storage Temperature Range	T_{stg}	-55 to +150	$^\circ C$

ELECTRICAL CHARACTERISTICS(Rating at 25°C ambient temperature unless otherwise specified.)

Symbol	Parameter	Conditions	Value			Unit
			Min.	Typ.	Max.	
V _{BR}	Breakdown Voltage	I _T =100μA	100	-	-	V
		I _T =5μA	75	-	-	V
V _F	Forward Voltage	I _F =1mA	-	-	0.715	V
		I _F =10mA	-	-	0.855	V
		I _F =50mA	-	-	1	V
		I _F =150mA	-	-	1.25	V
I _R	Reverse Current	V _R =20V, T _j =25°C	-	-	25	nA
		V _R =20V, T _j =150°C	-	-	50	μA
		V _R =75V, T _j =25°C	-	-	1	μA
		V _R =75V T _j =150°C	-	-	50	μA
C _T	Capacitance	V _R =0V, f=1MHz	-	4	-	pF
T _{rr}	Reverse Recovery Time	I _F =I _R =10mA I _{RR} =1mA, V _R =6V	-	-	4	ns

PACKAGE MECHANICAL DATA

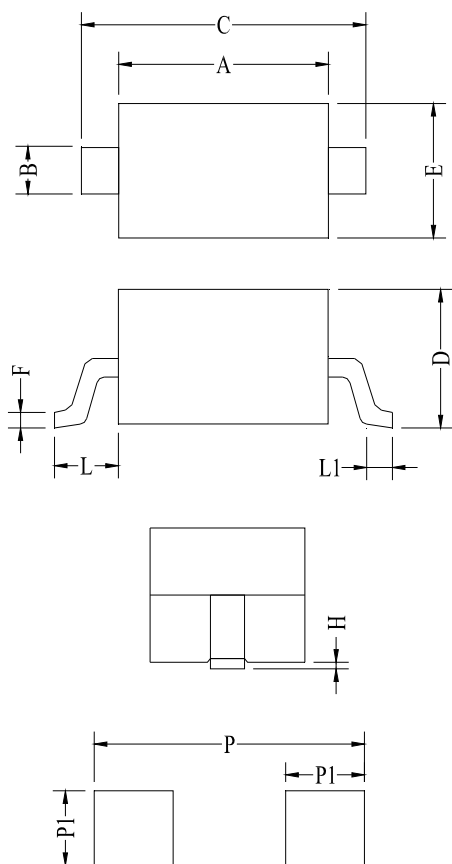

Land Pattern

Symbol	Millimeters			Inches		
	Min	Typ	Max	Min	Typ	Max
A	1.60	1.70	1.80	0.063	0.067	0.071
B	0.25	0.32	0.40	0.010	0.013	0.016
C	2.30	2.60	2.80	0.091	0.102	0.110
D	0.80	0.95	1.10	0.031	0.037	0.043
E	1.20	1.30	1.40	0.047	0.051	0.055
F	0.08	0.13	0.18	0.003	0.005	0.007
L	0.475REF			0.019REF		
L1	0.25	0.33	0.40	0.010	0.013	0.016
H	0.00	0.06	0.14	0.000	0.002	0.006
P	3.00			0.118		
P1	0.80			0.031		

7 INCH-TAPE AND REEL INFORMATION-SOD-323

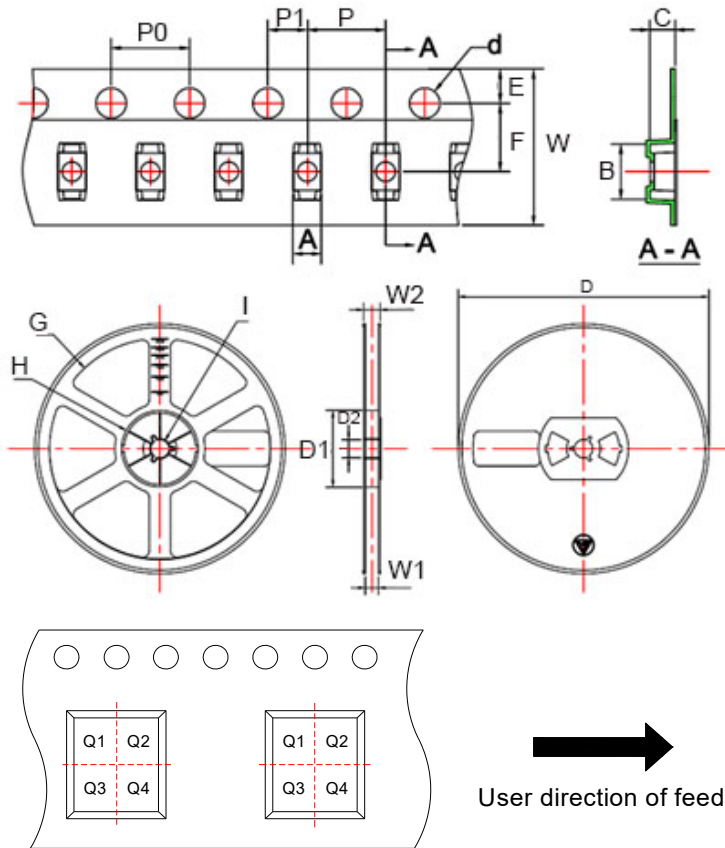

Pin 1 quadrant:Q1&Q2

Packaging description:

SOD-323 parts are shipped in tape. The carrier tape is made from a dissipative(carbon filled) polycarbonate resin. The cover tape is a multilayer film(heat activated adhesive in nature)primarily composed of polyester film, adhesive layer, sealant, and anti-static sprayed agent. The reels are blue in color and made of recyclable plastic.

Symbol	Millimeters	Inches
	Typ	Typ
A	1.46	0.057
B	2.90	0.114
C	1.25	0.049
d	ø1.50	ø0.059
E	1.75	0.069
F	3.50	0.138
P0	4.00	0.157
P	4.00	0.157
P1	2.00	0.079
W	8.00	0.315
D	ø178.0	ø7.008
D1	54.40	2.142
D2	13.00	0.512
G	R78.0	R3.071
H	R25.60	R1.008
I	R6.50	R0.256
W1	9.50	0.374
W2	12.30	0.484

ORDERING INFORMATION

PART NO.	PACKAGE TYPE	QUANTITY REEL	DESCRIPTION
1N4148WS	SOD-323	3,000	7 inch reel pack

13 INCH-TAPE AND REEL INFORMATION-SOD-323

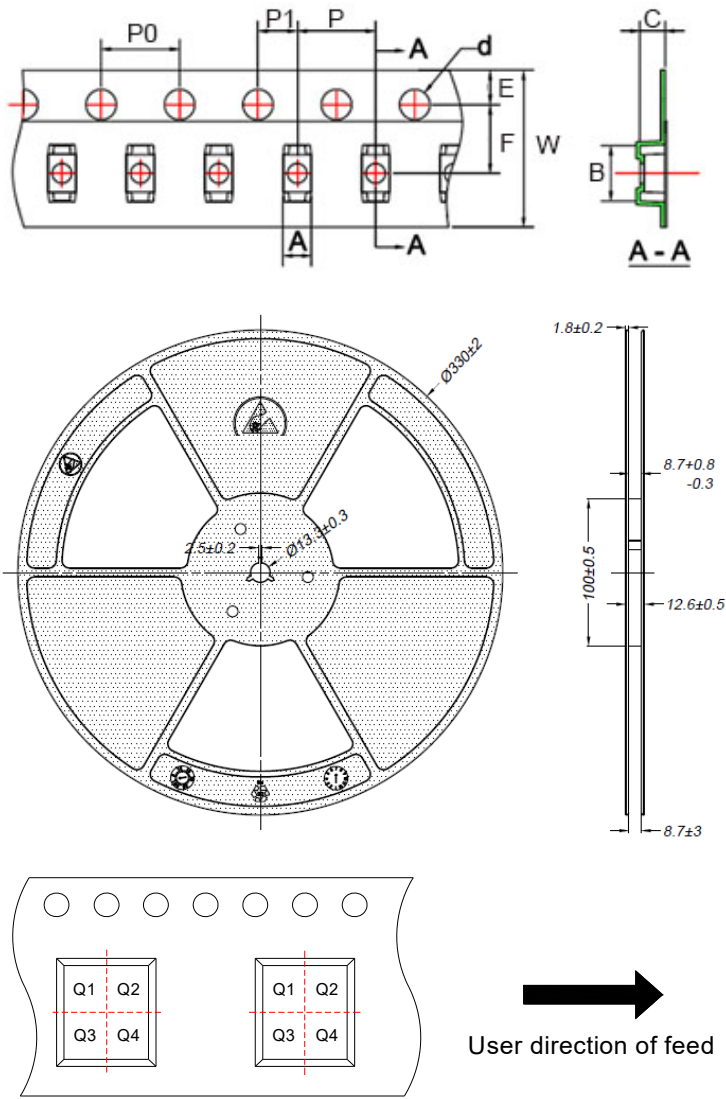

Symbol	Millimeters	Inches
	Typ	Typ
A	1.46	0.057
B	2.90	0.114
C	1.25	0.049
d	$\phi 1.50$	$\phi 0.059$
E	1.75	0.069
F	3.50	0.138
P0	4.00	0.157
P	4.00	0.157
P1	2.00	0.079
W	8.00	0.315

Pin 1 quadrant: Q1&Q2

ORDERING INFORMATION

PART NO.	PACKAGE TYPE	QUANTITY REEL	DESCRIPTION
1N4148WS-13	SOD-323	10,000	13 inch reel pack

MARKING CODE

Part Number	Marking Code
1N4148WS	

CHARACTERISTICS CURVE

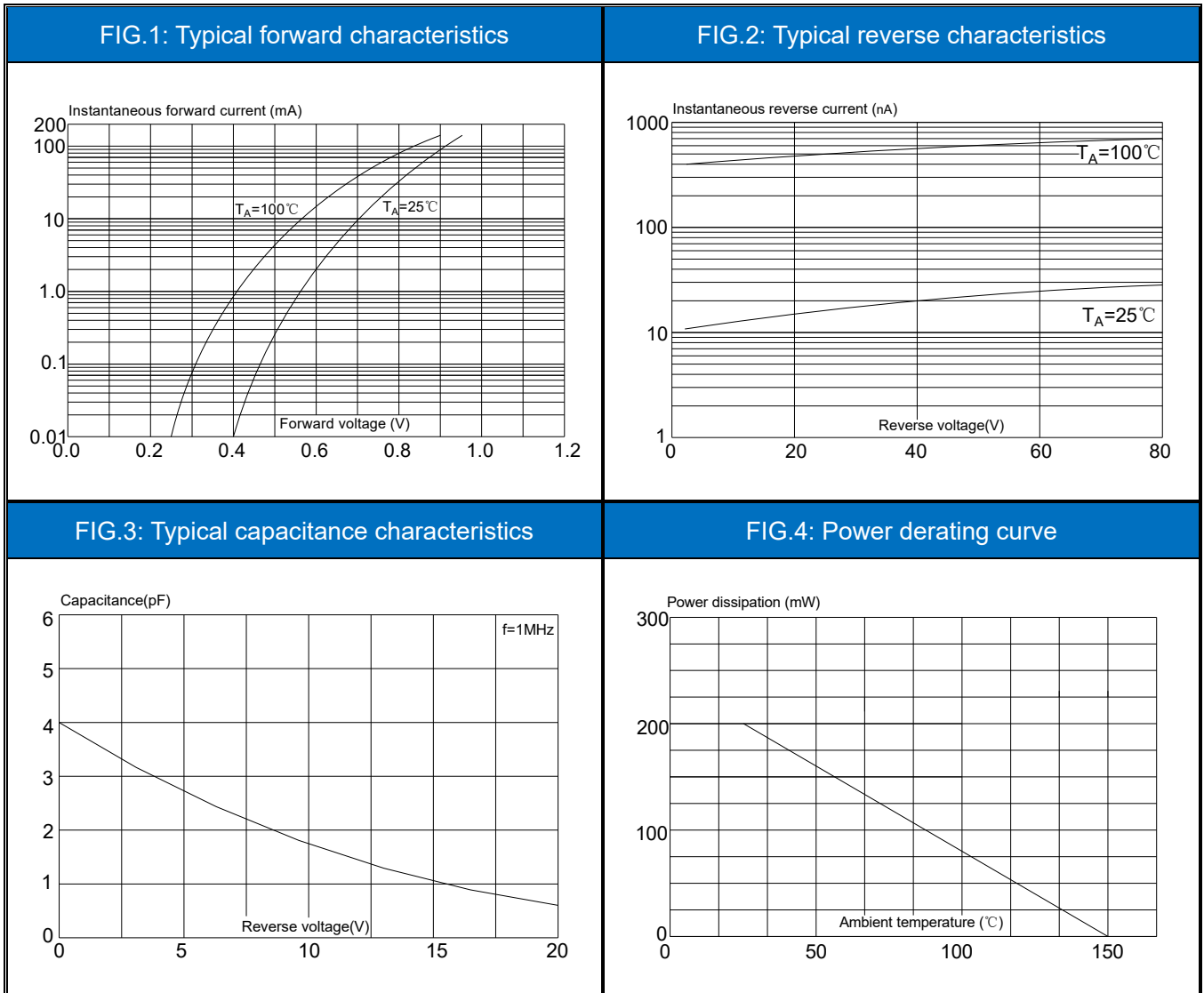

JieJie products are not designed for, and shall not be used for, any purpose (including, without limitation, automotive, military, aerospace, medical, life-saving, life-sustaining or nuclear facility applications, devices intended for surgical implant into the body, or any other application in which the failure or lack of desired operation of the product may result in personal injury, death, or property damage) other than those expressly set forth in applicable JieJie product documentation. Warranties granted by JieJie shall be deemed void for products used for any purpose not expressly set forth in applicable JieJie documentation. JieJie shall not be liable for any claims or damages arising out of products used in applications not expressly intended by JieJie as set forth in applicable JieJie documentation. The sale and use of JieJie products is subject to JieJie terms and conditions of sale, unless otherwise agreed by JieJie.

Information furnished in this document is believed to be accurate and reliable. However, Jiangsu JieJie Microelectronics Co., Ltd. assumes no responsibility for the consequences of use without consideration for such information nor use beyond it.

Information mentioned in this document is subject to change without notice, apart from that when an agreement is signed, Jiangsu JieJie complies with the agreement.

Products and information provided in this document have no infringement of patents. Jiangsu JieJie assumes no responsibility for any infringement of other rights of third parties which may result from the use of such products and information.

This document is the 2.5th version which is made in 14-Sep.-2024. This document supersedes and replaces all information previously supplied.

 is a registered trademark of Jiangsu JieJie Microelectronics Co., Ltd.

Copyright ©2024 Jiangsu JieJie Microelectronics Co., Ltd. Printed All rights reserved.