



### FEATURES

- ◇ 6000 Watts peak pulse power dissipation( $t_P=8/20\mu s$ )
- ◇ Low leakage current
- ◇ Low clamping voltage
- ◇ Solid-state silicon-avalanche technology
- ◇ RoHS compliant

### MAIN APPLICATIONS

- ◇ Power lines
- ◇ Personal digital assistants (PDA's)
- ◇ Microprocessors based equipment
- ◇ Notebooks, desktops, and servers
- ◇ Cell phone handsets and accessories
- ◇ Portable electronics
- ◇ Peripherals

### PROTECTION SOLUTION TO MEET

- ◇ IEC61000-4-2 (ESD)  $\pm 30kV$  (air),  $\pm 30kV$  (contact)
- ◇ IEC61000-4-4 (EFT) 40A (5/50ns)
- ◇ IEC61000-4-5 (Lightning) 120A (8/20 $\mu s$ )

### MECHANICAL CHARACTERISTICS

- ◇ DFN2x2-3L package
- ◇ Molding compound flammability rating: UL 94V-0
- ◇ Quantity per reel: 3,000pcs
- ◇ Lead finish: lead free
- ◇ Marking code: T24



DFN2x2-3L

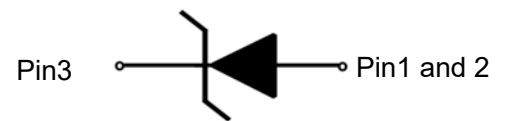

Circuit Diagram

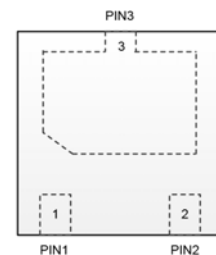

Pin Configuration

**ABSOLUTE MAXIMUM RATINGS** ( $T_A=25^{\circ}\text{C}$ , RH=45%-75%, unless otherwise noted)

Parameter	Symbol	Value	Unit
Peak pulse power dissipation at 8/20 $\mu\text{s}$ waveform	$P_{PP}$	6000	W
ESD per IEC 61000-4-2 (Air) ESD per IEC 61000-4-2 (Contact)	$V_{ESD}$	+/- 30 +/- 30	kV
Lead soldering temperature	$T_L$	260 (10 sec.)	$^{\circ}\text{C}$
Operating junction temperature range	$T_J$	-55 to +125	$^{\circ}\text{C}$
Storage temperature range	$T_{STG}$	-55 to +150	$^{\circ}\text{C}$

**ELECTRICAL CHARACTERISTICS** ( $T_A=25^{\circ}\text{C}$ )

Parameter	Symbol	Conditions	Min	Typ	Max	Unit
Reverse working voltage	$V_{RWM}$				24	V
Reverse breakdown voltage	$V_{BR}$	$I_T=1\text{mA}$	26	27	30	V
Reverse leakage current	$I_R$	$V_{RWM}=24\text{V}$			1	$\mu\text{A}$
Clamping voltage	$V_C$	$I_{PP}=50\text{A}, t_p=8/20\mu\text{s}$		45	50	V
		$I_{PP}=120\text{A}, t_p=8/20\mu\text{s}$		52	60	
Junction capacitance	$C_J$	$V_{RWM}=0\text{V}, f=1\text{MHz}$		750		pF

**RATINGS AND V-I CHARACTERISTICS CURVES** ( $T_A=25^{\circ}\text{C}$ , unless otherwise noted)

**FIG.1: V- I curve characteristics (Uni-directional)**

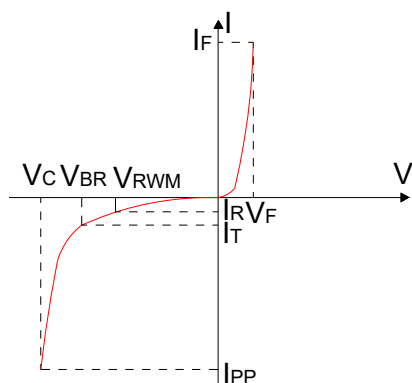

**FIG.2: Pulse waveform (8/20 $\mu\text{s}$ )**

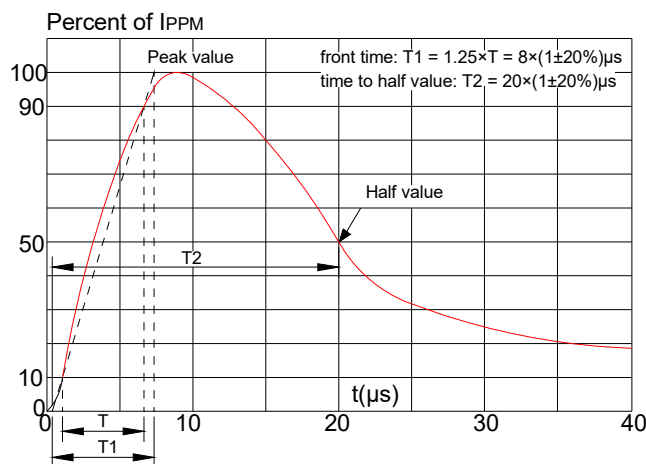

FIG.3: Pulse derating curve

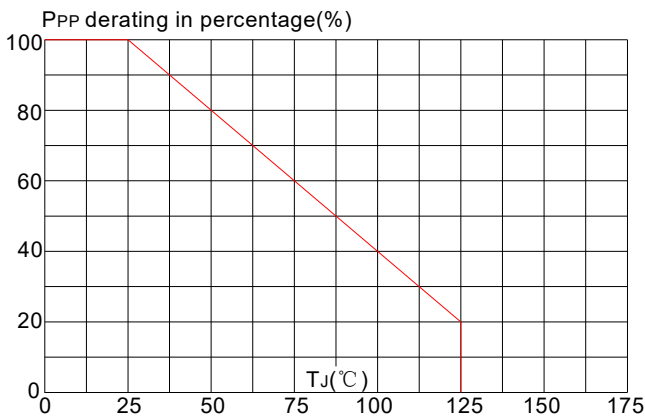

FIG.4: ESD clamping(30kV contact)

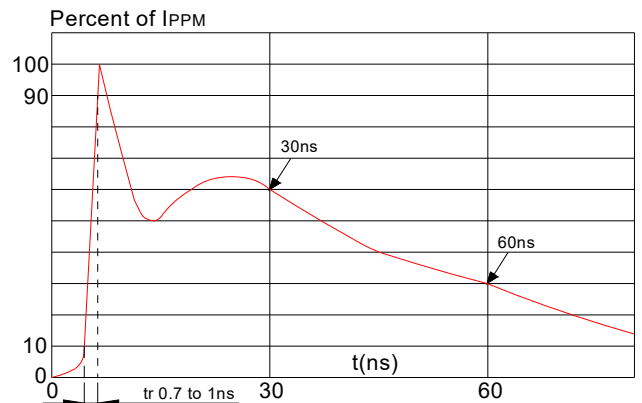

FIG.5:Clamping voltage vs.peak pulse current

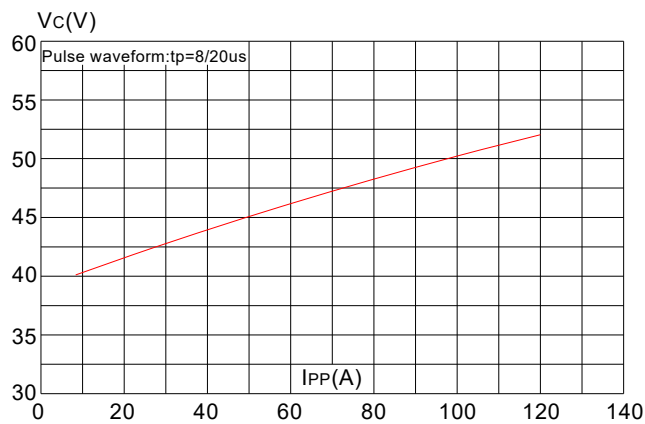
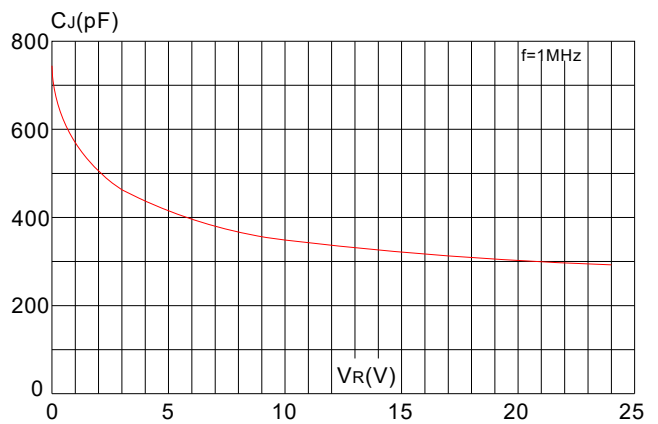
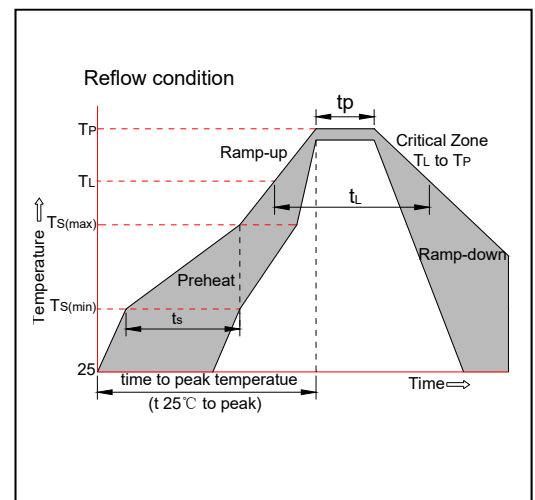

FIG.6:Capacitance vs.reverse voltage



SOLDERING PARAMETERS

Reflow Condition		Pb-Free assembly (see figure at right)
Pre Heat	-Temperature Min ( $T_{s(min)}$ )	+150°C
	-Temperature Max( $T_{s(max)}$ )	+200°C
	-Time (Min to Max) ( $t_s$ )	60-180 secs.
Average ramp up rate (Liquidus Temp ( $T_L$ )to peak)		3°C/sec. Max
$T_{s(max)}$ to $T_L$ - Ramp-up Rate		3°C/sec. Max
Reflow	-Temperature( $T_L$ )(Liquidus)	+217°C
	-Temperature( $t_L$ )	60-150 secs.
Peak Temp ( $T_p$ )		+260(+0/-5)°C
Time within 5°C of actual Peak Temp ( $t_p$ )		20-40secs.
Ramp-down Rate		6°C/sec. Max
Time 25°C to Peak Temp ( $T_p$ )		8 min. Max
Do not exceed		+260°C



**PACKAGE MECHANICAL DATA**

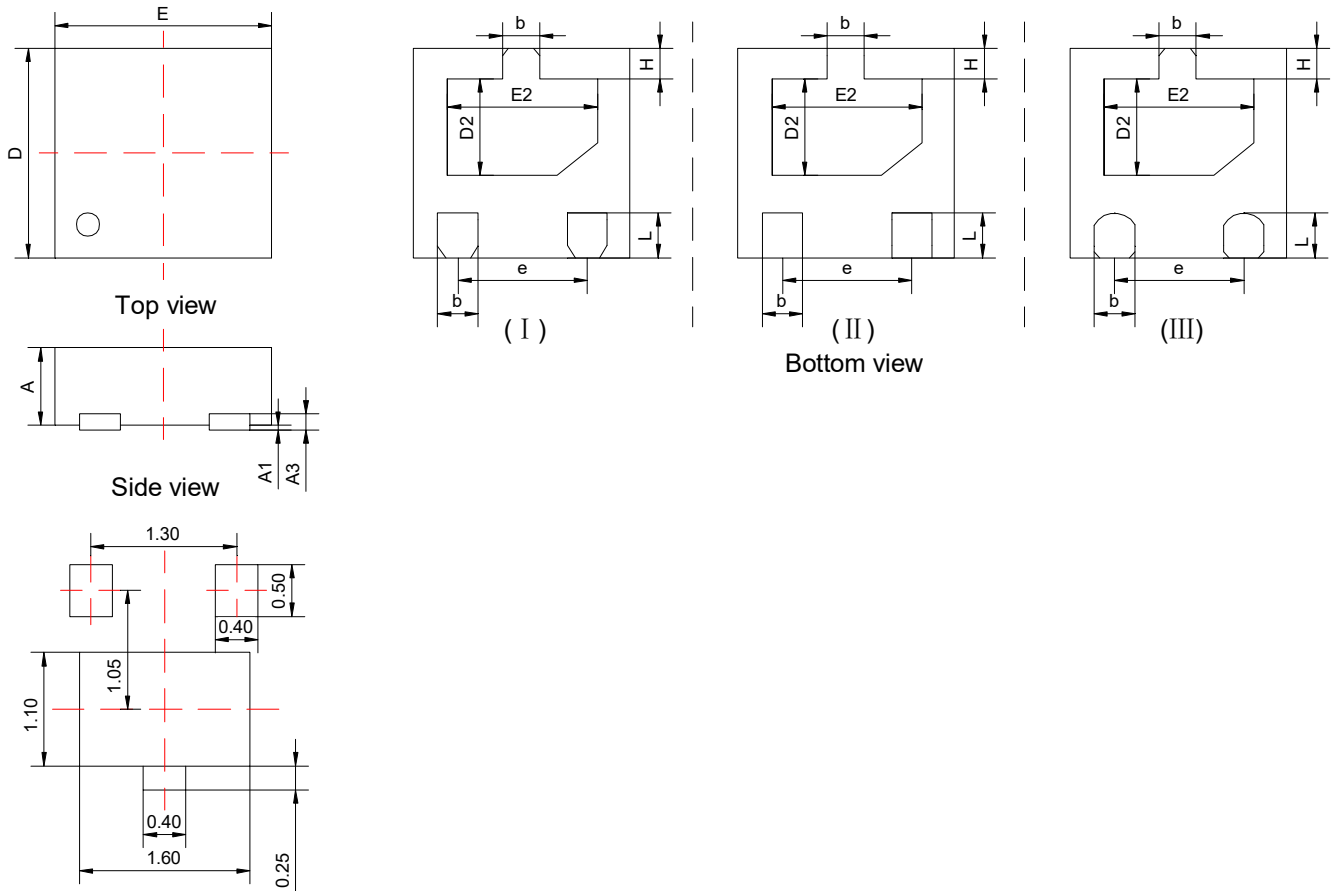

Recommended soldering footprint(mm)

Symbol	Millimeters			Inches		
	Min.	Typ.	Max.	Min.	Typ.	Max.
A	0.45	0.50	0.60	0.018	0.020	0.024
A1	0.00	0.02	0.05	0.000	0.001	0.002
A3	0.15REF			0.006REF		
b	0.25	0.30	0.35	0.010	0.012	0.014
D	1.90	2.00	2.10	0.075	0.079	0.083
E	1.90	2.00	2.10	0.075	0.079	0.083
D2	0.85	1.05	1.15	0.033	0.041	0.045
E2	1.40	1.50	1.60	0.055	0.059	0.063
e	1.30BSC			0.051BSC		
H	0.20	0.25	0.30	0.008	0.010	0.012
L	0.35	0.40	0.45	0.014	0.016	0.018

**TAPE AND REEL INFORMATION-DFN2x2-3L**

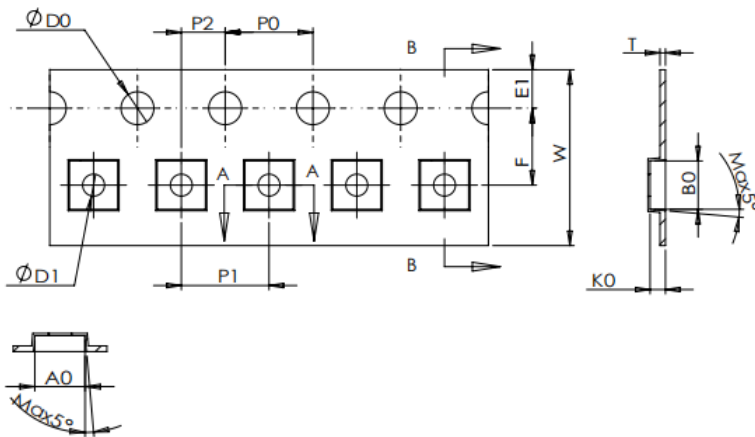

Symbol	Dimensions	
	Millimeters	Inches
	Typ.	Typ.
W	8.00	0.315
P1	4.00	0.157
E1	1.75	0.069
F	3.50	0.138
D0	1.55	0.061
D1	1.00	0.039
P0	4.00	0.157
P1	4.00	0.157
P2	2.00	0.079
A0	2.20	0.087
B0	2.20	0.087
K0	0.70	0.028
T	0.23	0.009

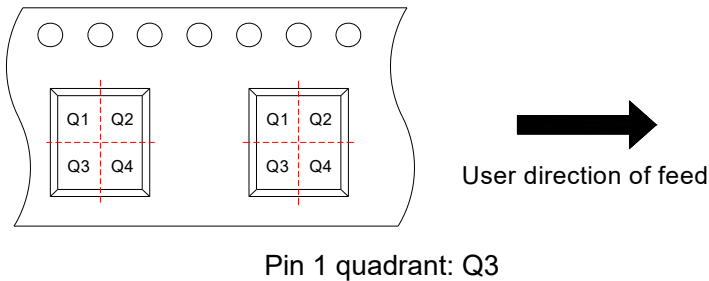

**ORDERING INFORMATION**

PART No.	PACKAGE TYPE	QUANTITY(PCS) REEL	DESCRIPTION
JEU24N3-CO	DFN2x2-3L	3,000	7 Inch

**MARKING CODE**

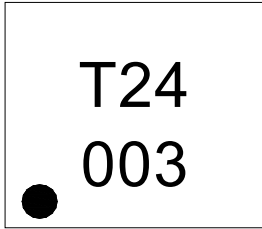
Part Number	Marking Code
JEU24N3-CO	<div style="border: 1px solid black; padding: 10px; display: inline-block;">  </div>

JieJie products are not designed for, and shall not be used for, any purpose (including, without limitation, automotive, military, aerospace, medical, life-saving, life-sustaining or nuclear facility applications, devices intended for surgical implant into the body, or any other application in which the failure or lack of desired operation of the product may result in personal injury, death, or property damage) other than those expressly set forth in applicable JieJie product documentation. Warranties granted by JieJie shall be deemed void for products used for any purpose not expressly set forth in applicable JieJie documentation. JieJie shall not be liable for any claims or damages arising out of products used in applications not expressly intended by JieJie as set forth in applicable JieJie documentation. The sale and use of JieJie products is subject to JieJie terms and conditions of sale, unless otherwise agreed by JieJie.

Information furnished in this document is believed to be accurate and reliable. However, Jiangsu JieJie Microelectronics Co., Ltd. assumes no responsibility for the consequences of use without consideration for such information nor use beyond it.

Information mentioned in this document is subject to change without notice, apart from that when an agreement is signed, Jiangsu JieJie complies with the agreement.

Products and information provided in this document have no infringement of patents. Jiangsu JieJie assumes no responsibility for any infringement of other rights of third parties which may result from the use of such products and information.

This document is the first version which is made in 24-May-2024. This document supersedes and replaces all information previously supplied.

 is a registered trademark of Jiangsu JieJie Microelectronics Co., Ltd.

Copyright ©2024 Jiangsu JieJie Microelectronics Co., Ltd. Printed All rights reserved.