

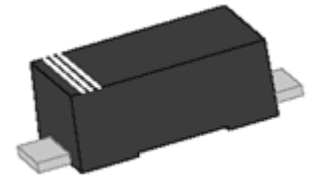


## SMF3.3AL 400W Transient Voltage Suppressor

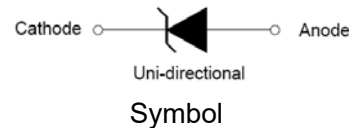
Rev.1.3

### FEATURES

- ✧ Planar technology.
- ✧ Halogen-free and RoHS compliant.
- ✧ Stand-off voltage: 3.3V.
- ✧ 400W peak pulse power capability at 10/1000μs waveform.
- ✧ Meets MSL level 1, per J-STD-020, LF maximum peak of 260°C.
- ✧ Terminal: solder plated, solderable per J-STD-002.
- ✧ Excellent clamping capability.
- ✧ Fast response time.
- ✧ IEC61000-4-2 (ESD) ±30kV (air), ±30kV (contact).



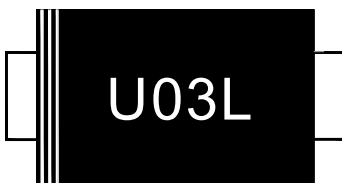
SOD-123FL



### ABSOLUTE MAXIMUM RATINGS<sub>(T<sub>A</sub>=25°C, RH=45%-75%, unless otherwise noted)</sub>

| Parameter  | Symbol                           | Value       | Unit |
|--|----------------------------------|-------------|------|
| Storage and operating junction temperature range   | T <sub>STG</sub> /T <sub>J</sub> | -55 to +150 | °C   |
| Peak pulse power dissipation at 10/1000μs waveform | P <sub>PP</sub>                  | 400         | W    |
| Typical thermal resistance junction to lead        | R <sub>θJL</sub>                 | 100         | °C/W |
| Typical thermal resistance junction to ambient     | R <sub>θJA</sub>                 | 220         | °C/W |

### MARKING



U03L : Device Marking Code

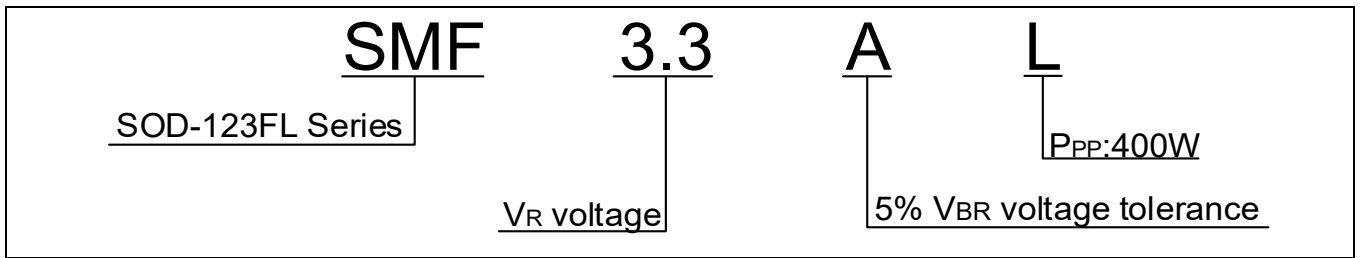
### ELECTRICAL CHARACTERISTICS<sub>(T<sub>A</sub>=25°C)</sub>

| Part Number | V <sub>R</sub> | I <sub>R@V<sub>R</sub></sub> | V <sub>BR@I<sub>T</sub></sub> | I <sub>T</sub> | V <sub>C@I<sub>PP</sub></sub> | I <sub>PP</sub> <sup>①</sup> | Co <sup>②</sup> | Marking |
|-------------|----------------|------------------------------|-------------------------------|----------------|-------------------------------|------------------------------|-----------------|---------|
|             | V              | μA(max)                      | V(min)                        | mA             | V(max)                        | A(max)                       | pF(typ.)        |         |
| SMF3.3AL    | 3.3            | 80                           | 4.1                           | 1              | 7.3                           | 54.7                         | 2900            | U03L    |

① Surge waveform: 10/1000μs

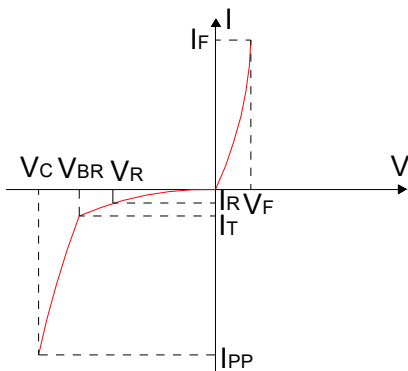
② Co is measured at: V<sub>bias</sub>=0V, V<sub>RMS</sub>=0.1V, f=1MHz

ORDERING INFORMATION

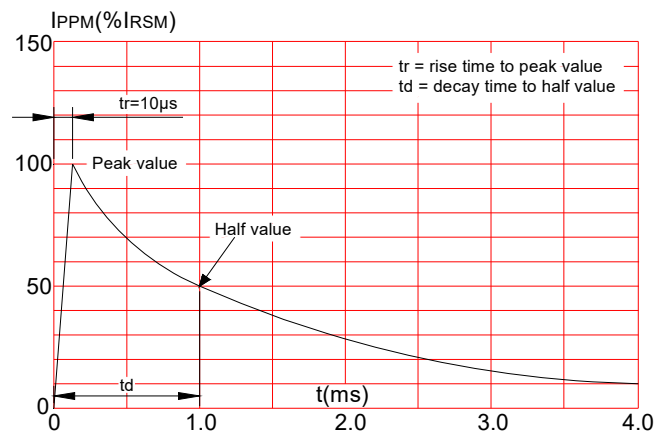


RATINGS AND V-I CHARACTERISTICS CURVES ( $T_A=25^\circ C$ , unless otherwise noted)

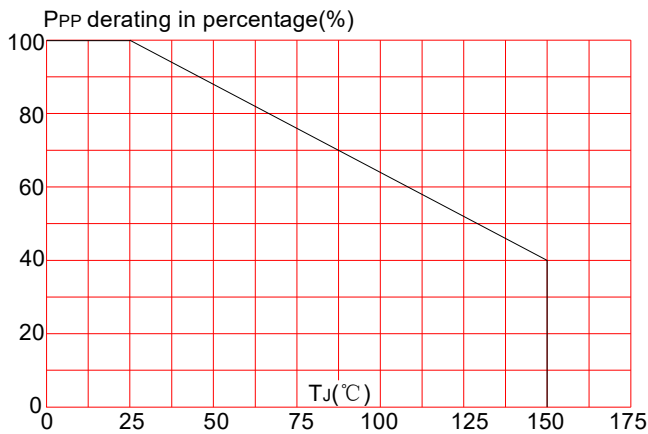
**FIG.1: V- I curve characteristics (Uni-directional)**



**FIG.2: Pulse waveform**

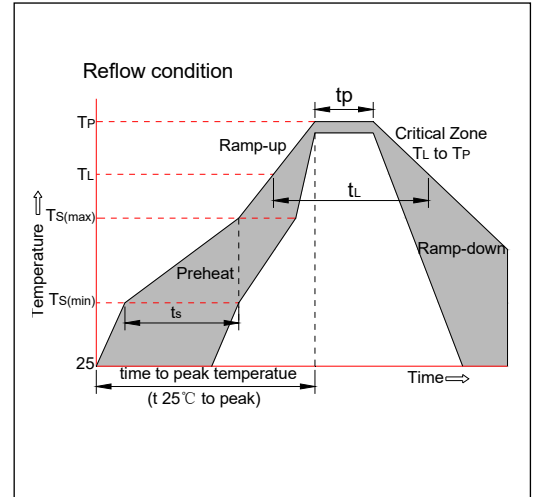


**FIG.3: Pulse derating curve**

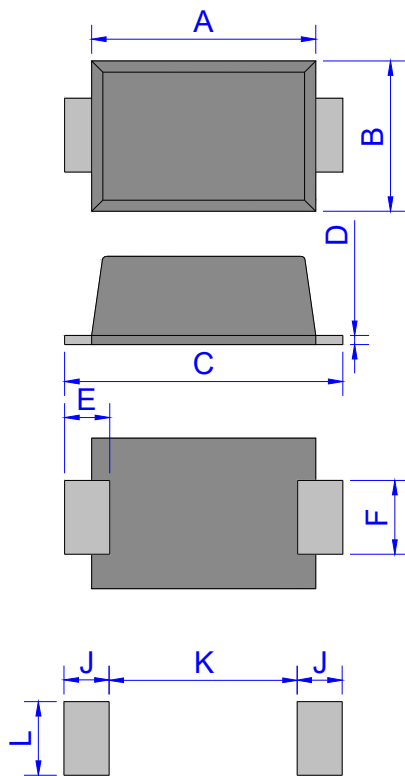


**SOLDERING PARAMETERS**

|   |                                   |   |
|---|-----------------------------------|---|
| Reflow Condition                                      |                                   | Pb-Free assembly<br>(see figure at right) |
| Pre Heat  | -Temperature Min ( $T_{s(min)}$ ) | +150°C                                    |
|   | -Temperature Max( $T_{s(max)}$ )  | +200°C                                    |
|   | -Time (Min to Max) (ts)           | 60-180 secs.                              |
| Average ramp up rate (Liquidus Temp ( $T_L$ )to peak) |                                   | 3°C/sec. Max                              |
| $T_{s(max)}$ to $T_L$ - Ramp-up Rate                  |                                   | 3°C/sec. Max                              |
| Reflow  | -Temperature( $T_L$ )(Liquidus)   | +217°C                                    |
|   | -Temperature( $t_L$ )             | 60-150 secs.                              |
| Peak Temp ( $T_p$ )                                   |                                   | +260(+0/-5)°C                             |
| Time within 5°C of actual Peak Temp ( $t_p$ )         |                                   | 20-40secs.                                |
| Ramp-down Rate  |                                   | 6°C/sec. Max                              |
| Time 25°C to Peak Temp ( $T_p$ )                      |                                   | 8 min. Max                                |
| Do not exceed   |                                   | +260°C                                    |



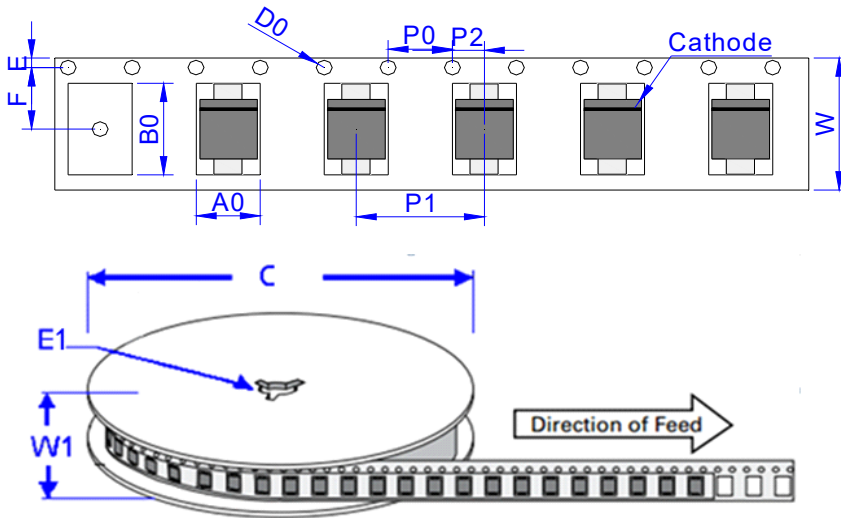
**PACKAGE MECHANICAL DATA**



SOD-123FL

| Ref. | Dimensions  |      |        |       |
|------|-------------|------|--------|-------|
|      | Millimeters |      | Inches |       |
|      | Min.        | Max. | Min.   | Max.  |
| A    | 2.60        | 3.00 | 0.102  | 0.118 |
| B    | 1.60        | 2.00 | 0.063  | 0.079 |
| C    | 3.45        | 3.95 | 0.136  | 0.156 |
| D    | 0.10        | 0.25 | 0.004  | 0.01  |
| E    | 0.3         | 0.9  | 0.012  | 0.035 |
| F    | 0.80        | 1.20 | 0.031  | 0.047 |
| G    | 0.95        | 1.35 | 0.037  | 0.053 |
| J    | 1.30        |      | 0.051  |       |
| K    |             | 1.70 |        | 0.067 |
| L    | 1.30        |      | 0.051  |       |

TAPE AND REEL SPECIFICATION-SOD-123FL



| Ref. | Dimensions  |               |
|------|-------------|---------------|
|      | Millimeters | Inches        |
| A0   | 1.95 ± 0.3  | 0.077 ± 0.012 |
| B0   | 3.95 ± 0.3  | 0.156 ± 0.012 |
| C    | 178         | 7.0           |
| D0   | 1.55 ± 0.1  | 0.061 ± 0.004 |
| E    | 1.75 ± 0.2  | 0.069 ± 0.008 |
| E1   | 13.3 ± 0.3  | 0.524 ± 0.012 |
| F    | 3.50 ± 0.2  | 0.138 ± 0.008 |
| P0   | 4.00 ± 0.2  | 0.157 ± 0.008 |
| P1   | 4.00 ± 0.2  | 0.157 ± 0.008 |
| P2   | 2.00 ± 0.2  | 0.079 ± 0.008 |
| W    | 8.0 ± 0.2   | 0.315 ± 0.008 |
| W1   | 11.5 ± 1.0  | 0.453 ± 0.039 |

| PART No. | UNIT WEIGHT (g/PCS) typ. | REEL (PCS) | PER CARTON (PCS) | DESCRIPTION      |
|----------|--------------------------|------------|------------------|------------------|
| SMF3.3AL | 0.0144                   | 3000       | 150,000          | 7 inch reel pack |


JieJie products are not designed for, and shall not be used for, any purpose (including, without limitation, automotive, military, aerospace, medical, life-saving, life-sustaining or nuclear facility applications, devices intended for surgical implant into the body, or any other application in which the failure or lack of desired operation of the product may result in personal injury, death, or property damage) other than those expressly set forth in applicable JieJie product documentation. Warranties granted by JieJie shall be deemed void for products used for any purpose not expressly set forth in applicable JieJie documentation. JieJie shall not be liable for any claims or damages arising out of products used in applications not expressly intended by JieJie as set forth in applicable JieJie documentation. The sale and use of JieJie products is subject to JieJie terms and conditions of sale, unless otherwise agreed by JieJie.

Information furnished in this document is believed to be accurate and reliable. However, Jiangsu JieJie Microelectronics Co., Ltd. assumes no responsibility for the consequences of use without consideration for such information nor use beyond it.

Information mentioned in this document is subject to change without notice, apart from that when an agreement is signed, Jiangsu JieJie complies with the agreement.

Products and information provided in this document have no infringement of patents. Jiangsu JieJie assumes no responsibility for any infringement of other rights of third parties which may result from the use of such products and information.

This document is the 1.3rd version which is made in 16-Oct.-2023. This document supersedes and replaces all information previously supplied.

 is a registered trademark of Jiangsu JieJie Microelectronics Co., Ltd.

Copyright ©2023 Jiangsu JieJie Microelectronics Co., Ltd. Printed All rights reserved.