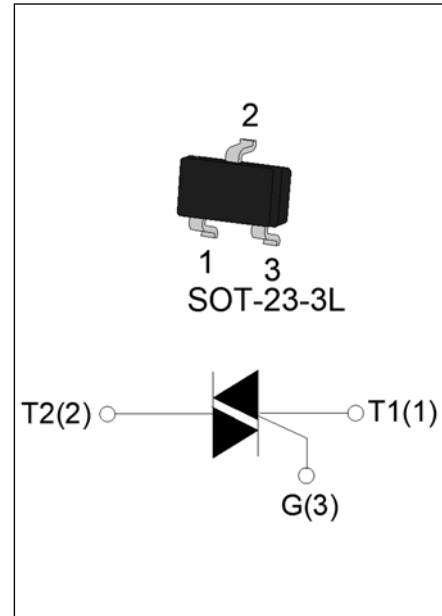

**97A6 0.5A TRIAC**

Rev.A.1.0

**DESCRIPTION:**

The 97A6 triac is suitable for general purpose AC switching. It can be used as an ON/OFF function in applications such as heating regulation, induction motor starting circuits, for phase control operation in light dimmers, motor speed controllers. Package SOT-23-3L is RoHS compliant.

**MAIN FEATURES**

Symbol	Value	Unit
$I_{T(RMS)}$	0.5	A
$V_{DRM}/V_{RRM}$	600	V
$I_{GT\ I/II/III/IV}$	5/5/5/10	mA

**ABSOLUTE MAXIMUM RATINGS**

Parameter		Symbol	Value	Unit
Storage junction temperature range		$T_{stg}$	-40-150	°C
Operating junction temperature range		$T_j$	-40-125	°C
Repetitive peak off-state voltage ( $T_j=25^\circ\text{C}$ )		$V_{DRM}$	600	V
Repetitive peak reverse voltage ( $T_j=25^\circ\text{C}$ )		$V_{RRM}$	600	V
RMS on-state current ( $T_c \leq 74^\circ\text{C}$ )		$I_{T(RMS)}$	0.5	A
Non repetitive surge peak on-state current (full cycle , $t_p=20\text{ms}$ , $T_j=25^\circ\text{C}$ )		$I_{TSM}$	6	A
Non repetitive surge peak on-state current (full cycle , $t_p=16.6\text{ms}$ , $T_j=25^\circ\text{C}$ )			6.6	
$I^2t$ value for fusing ( $t_p=10\text{ms}$ , $T_j=25^\circ\text{C}$ )		$I^2t$	0.18	$\text{A}^2\text{s}$
Critical rate of rise of on-state current ( $I_G=2 \times I_{GT}$ , $f=100\text{Hz}$ , $T_j=125^\circ\text{C}$ )	I - II	$di/dt$	50	$\text{A}/\mu\text{s}$
	III-IV		20	
Peak gate current ( $t_p=20\mu\text{s}$ , $T_j=125^\circ\text{C}$ )		$I_{GM}$	1	A
Average gate power dissipation ( $T_j=125^\circ\text{C}$ )		$P_{G(AV)}$	0.1	W
Peak gate power		$P_{GM}$	5	W
Peak pulse voltage ( $T_j=25^\circ\text{C}$ ; non-repetitive,off-state;FIG.8)		$V_{PP}$	1.5	kV

**ELECTRICAL CHARACTERISTICS** ( $T_j=25^\circ\text{C}$  unless otherwise specified)

Symbol	Test Condition	Quadrant	Value		Unit
$I_{GT}$	$V_D=12\text{V}$ $R_L=33\Omega$	I - II - III	MAX.	5	mA
		IV		10	
$V_{GT}$		ALL	MAX.	1.3	V
$V_{GD}$	$V_D=V_{DRM}$ $T_j=125^\circ\text{C}$ $R_L=3.3\text{K}\Omega$	ALL	MIN.	0.2	V
$I_L$	$I_G=1.2I_{GT}$	I - III - IV	MAX.	10	mA
		II		20	
$I_H$	$I_T=50\text{mA}$		MAX.	10	mA
$dV/dt$	$V_D=400\text{V}$ Gate Open $T_j=110^\circ\text{C}$		MIN.	60	$\text{V}/\mu\text{s}$
$(dV/dt)_c$	$(dI/dt)_c=0.3\text{A}/\text{ms}$ , $T_j=110^\circ\text{C}$		MIN.	5	$\text{V}/\mu\text{s}$
$t_{on}$	$I_G=20\text{mA}$ $I_A=200\text{mA}$ $I_R=20\text{mA}$ $T_j=25^\circ\text{C}$		TYP.	2.5	$\mu\text{s}$
$t_{off}$				25	

**STATIC CHARACTERISTICS**

Symbol	Parameter		Value(MAX.)	Unit
$V_{TM}$	$I_{TM}=0.85\text{A}$ $t_p=380\mu\text{s}$	$T_j=25^\circ\text{C}$	1.5	V
$V_{TO}$	Threshold voltage	$T_j=125^\circ\text{C}$	0.98	V
$R_D$	Dynamic resistance	$T_j=125^\circ\text{C}$	362	$\text{m}\Omega$
$I_{DRM}$	$V_D=V_{DRM}$ $V_R=V_{RRM}$	$T_j=25^\circ\text{C}$	5	$\mu\text{A}$
$I_{RRM}$		$T_j=125^\circ\text{C}$	0.15	mA

**THERMAL RESISTANCES**

Symbol	Parameter	Value	Unit
$R_{th(j-c)}$	junction to case (AC)	75	$^\circ\text{C}/\text{W}$
$R_{th(j-a)}$	junction to ambient (AC, in free air, $S=5\text{cm}^2$ )	120	$^\circ\text{C}/\text{W}$

MARKING

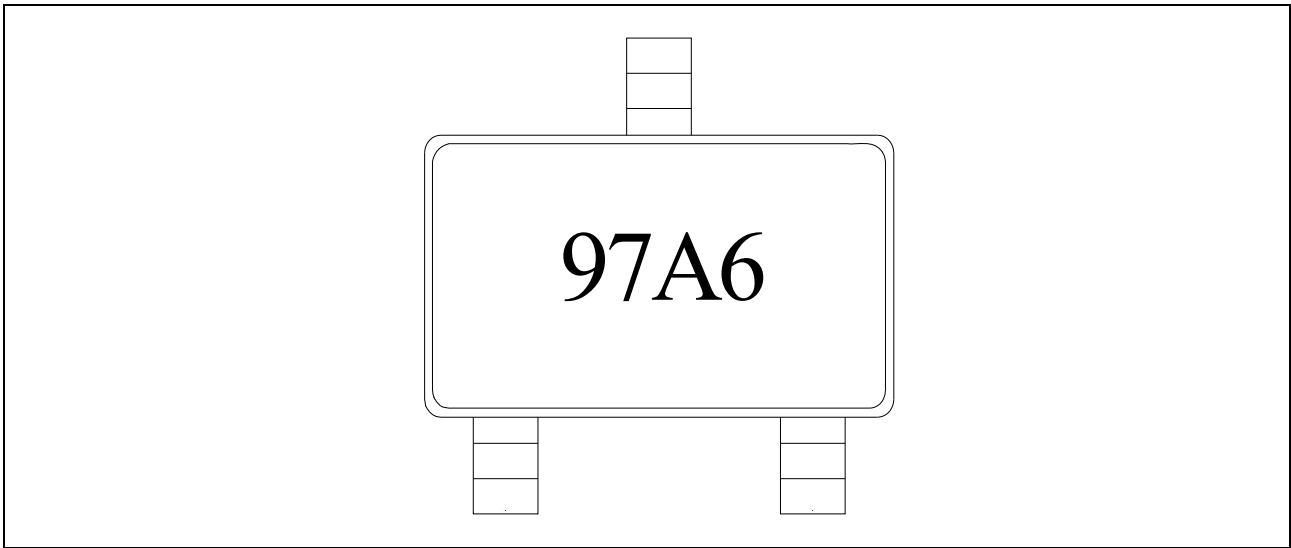

**FIG.1** Maximum power dissipation versus RMS on-state current

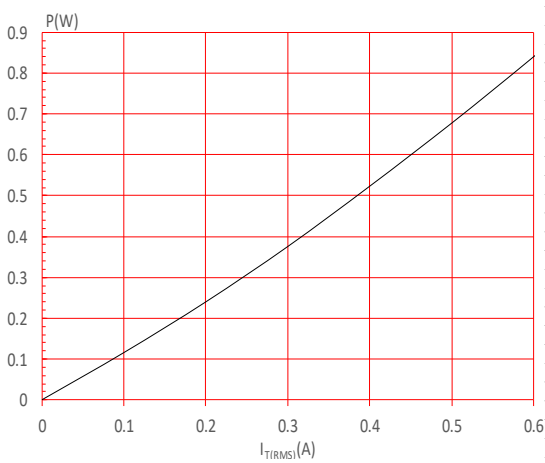

**FIG.2:** RMS on-state current versus case temperature

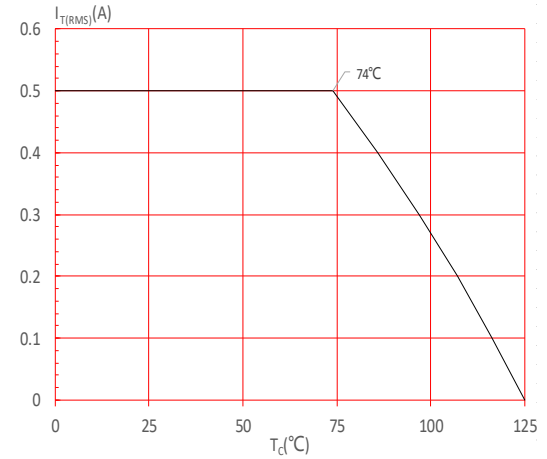

**FIG.3:** RMS on-state current versus ambient temperature (printed circuit board FR4, copper thickness: 35μm) (full cycle)

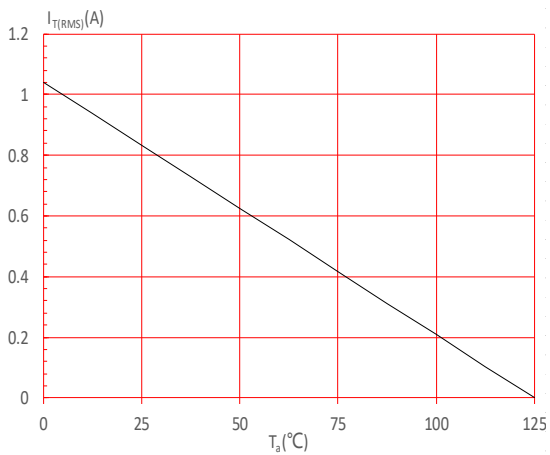

**FIG.4:** Surge peak on-state current versus number of cycles

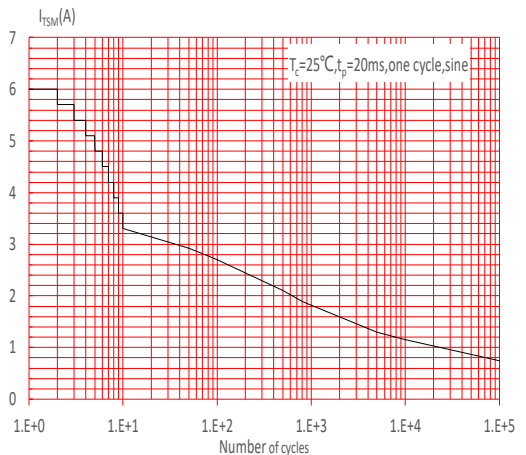

FIG.5: On-state characteristics

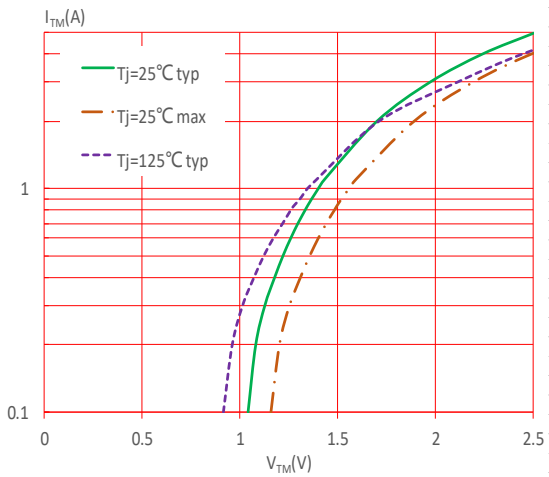

FIG.6: Non-repetitive surge peak on-state current for a sinusoidal pulse with width  $t_p < 20\text{ms}$ , and corresponding value of  $I^2t$  ( I - II:  $di/dt < 50\text{A}/\mu\text{s}$ ; III-IV:  $di/dt < 20\text{A}/\mu\text{s}$ )

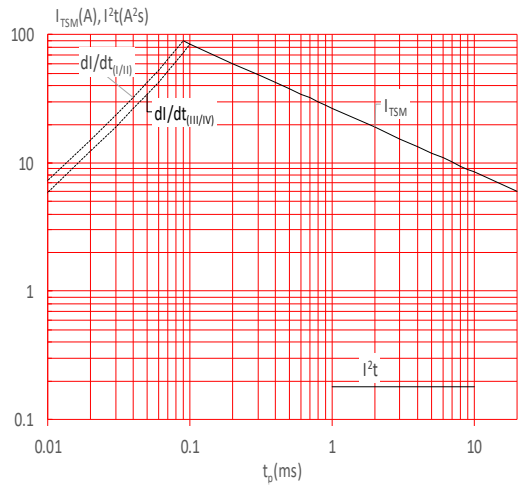

FIG.7: Relative variations of gate trigger current, holding current and latching current versus junction temperature

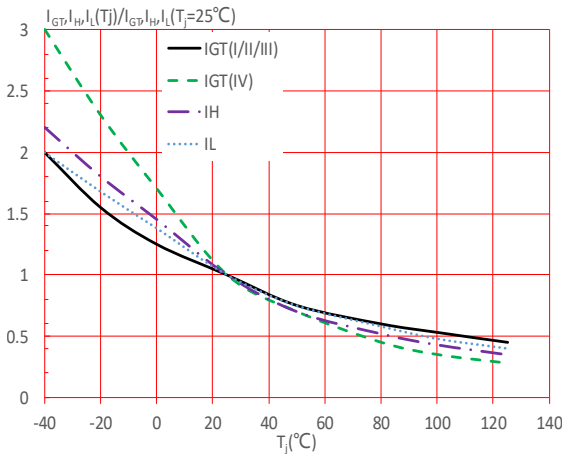
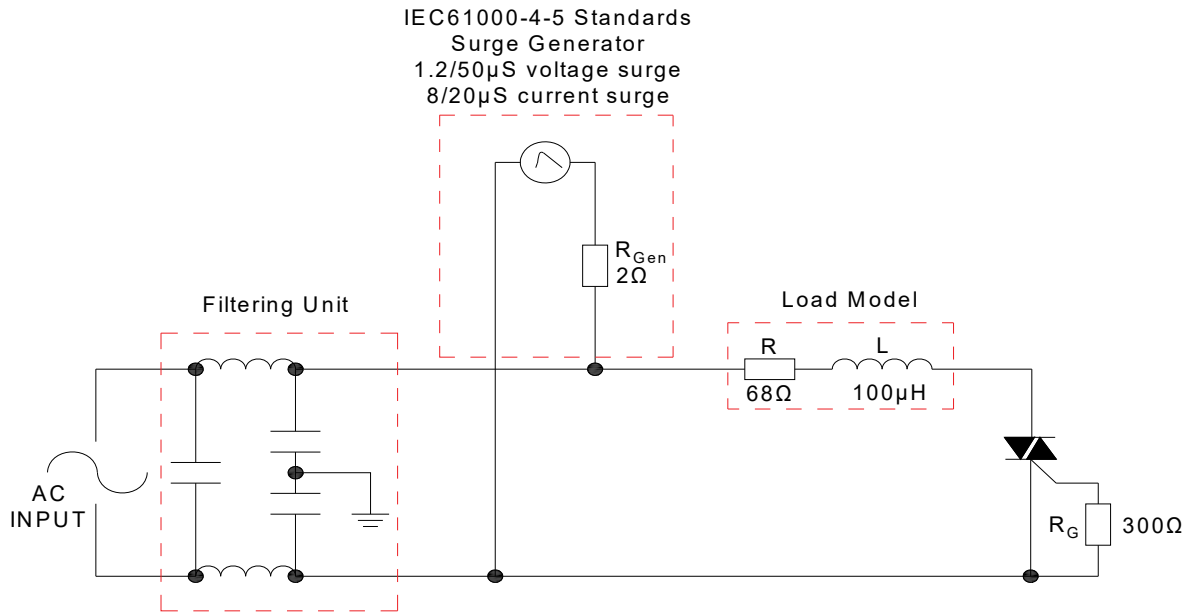
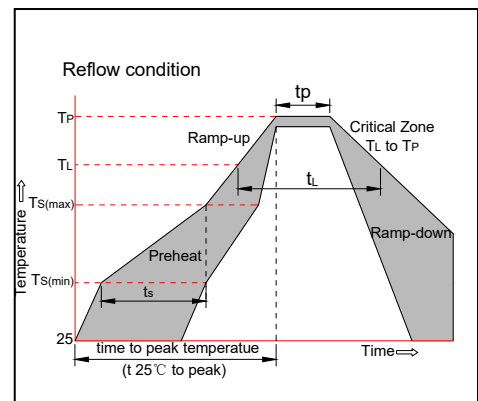

FIG.8: Test circuit for inductive and resistive loads to IEC-61000-4-5 standards



**SOLDERING PARAMETERS**

Reflow Condition		Pb-Free assembly (see figure at right)
Pre Heat	-Temperature Min (T <sub>s(min)</sub> )	+150°C
	-Temperature Max(T <sub>s(max)</sub> )	+200°C
	-Time (Min to Max) (ts)	60-180 secs.
Average ramp up rate (Liquidus Temp (T <sub>L</sub> )to peak)		3°C/sec. Max
T <sub>s(max)</sub> to T <sub>L</sub> - Ramp-up Rate		3°C/sec. Max
Reflow	-Temperature(T <sub>L</sub> ) (Liquidus)	+217°C
	-Temperature(t <sub>L</sub> )	60-150 secs.
Peak Temp (T <sub>p</sub> )		+260(+0/-5)°C
Time within 5°C of actual Peak Temp (t <sub>p</sub> )		20-40secs.
Ramp-down Rate		6°C/sec. Max
Time 25°C to Peak Temp (T <sub>P</sub> )		8 min. Max
Do not exceed		+260°C



## ORDERING INFORMATION

Order code	Voltage $V_{DRM}/V_{RRM}$ (V)	IGT(mA)		Package	Base qty. (pcs)	Delivery mode
		I -II-III	IV			
97A6	600	5	10	SOT-23-3L	3,000	Tape & Reel

## Document Revision History

Date	Revision	Changes
May.16, 2023	A.1.0	Last updated

PACKAGE MECHANICAL DATA

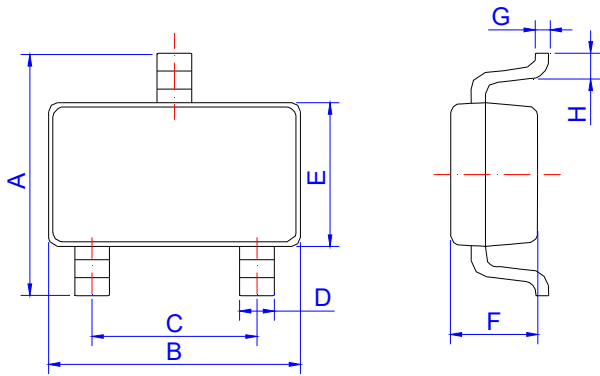

SOT-23-3L

Ref.	Dimensions					
	Millimeters			Inches		
	Min.	Typ.	Max.	Min.	Typ.	Max.
A	2.65	2.80	2.95	0.104	0.110	0.116
B	2.82	2.92	3.02	0.111	0.115	0.119
C	1.80	1.90	2.00	0.071	0.075	0.079
D	0.30	0.35	0.50	0.012	0.014	0.020
E	1.50	1.60	1.70	0.059	0.063	0.067
F	1.07	1.17	1.27	0.042	0.046	0.050
G	0.05	0.15	0.25	0.002	0.006	0.010
H	0.25	0.40	0.55	0.010	0.016	0.022

FOOTPRINT-SOT-23-3L (dimensions in mm)

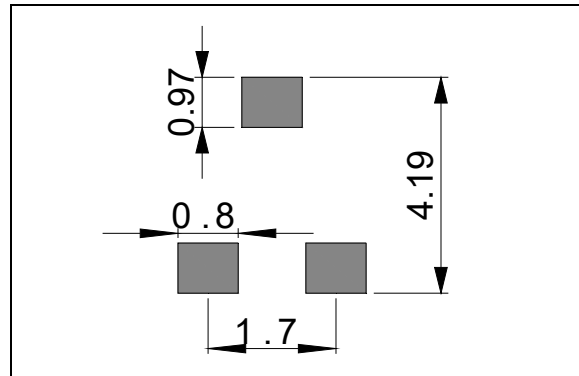

**DELIVERY MODE**

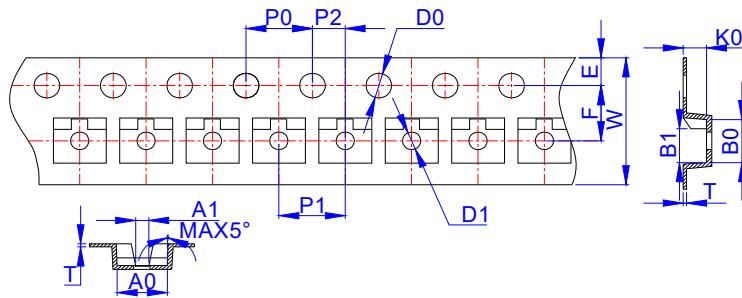

Ref.	Dimensions					
	Millimeters			Inches		
	Min.	Typ.	Max.	Min.	Typ.	Max.
A0	3.10	3.20	3.30	0.122	0.126	0.130
A1	1.02	1.04	1.06	0.040	0.041	0.042
B0	3.18	3.28	3.38	0.125	0.129	0.133
B1	2.39	2.49	2.59	0.094	0.098	0.102
K0	1.22	1.32	1.42	0.048	0.052	0.056
P0	3.90	4.00	4.10	0.154	0.157	0.161
P1	3.90	4.00	4.10	0.154	0.157	0.161
P2	1.95	2.00	2.05	0.077	0.079	0.081
T	0.15	0.20	0.25	0.006	0.008	0.010
E	1.65	1.75	1.85	0.065	0.069	0.073
F	3.45	3.50	3.55	0.136	0.138	0.140
D0	1.50	1.55	1.60	0.059	0.061	0.063
D1	1.00	1.10	1.20	0.039	0.043	0.047
W	7.90	8.00	8.20	0.311	0.315	0.323

PACKAGE	OUTLINE	REEL (PCS)	PER CARTON (PCS)	TAPE & REEL
SOT-23-3L	TAPING	3,000	120,000	7 inch



Information furnished in this document is believed to be accurate and reliable. However, Jiangsu JieJie Microelectronics Co., Ltd. assumes no responsibility for the consequences of use without consideration for such information nor use beyond it. Information mentioned in this document is subject to change without notice, apart from that when an agreement is signed, Jiangsu JieJie complies with the agreement.

Products and information provided in this document have no infringement of patents. Jiangsu JieJie assumes no responsibility for any infringement of other rights of third parties which may result from the use of such products and information. This document supersedes and replaces all information previously supplied.

 is a registered trademark of Jiangsu JieJie Microelectronics Co., Ltd.

Copyright © 2023 Jiangsu JieJie Microelectronics Co., Ltd. All rights reserved.