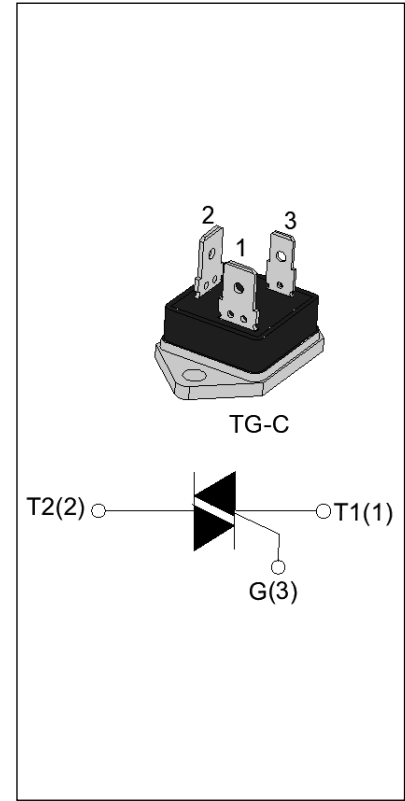

**JST80T-1200BW 80A TRIAC**

Rev.A.1.0

**DESCRIPTION:**

The JST80T-1200BW triac is suitable for general purpose AC switching. It can be used as an ON/OFF function in applications such as heating regulation, induction motor starting circuits, for phase control operation in light dimmers, motor speed controllers. JST80T-1200BW snubberless triac is especially recommended for use on inductive loads. By using a DBC, JST80T-1200BW provides a rated insulation voltage of 2500 VRMS, complying with UL standards (File ref: E252906). Package TG-C is RoHS compliant.

**MAIN FEATURES**

Symbol	Value	Unit
$I_{T(RMS)}$	80	A
$V_{DRM}/V_{RRM}$	1200	V
$I_{GT I/II/III}$	50/50/50	mA

**ABSOLUTE MAXIMUM RATINGS**

Parameter	Symbol	Value	Unit
Storage junction temperature range	$T_{stg}$	-40-150	°C
Operating junction temperature range	$T_j$	-40-125	°C
Repetitive peak off-state voltage ( $T_j=25^\circ\text{C}$ )	$V_{DRM}$	1200	V
Repetitive peak reverse voltage ( $T_j=25^\circ\text{C}$ )	$V_{RRM}$	1200	V
RMS on-state current ( $T_c \leq 89^\circ\text{C}$ )	$I_{T(RMS)}$	80	A
Non repetitive surge peak on-state current (full cycle, $t_p=20\text{ms}$ , $T_j=25^\circ\text{C}$ )	$I_{TSM}$	800	A
Non repetitive surge peak on-state current (full cycle, $t_p=16.6\text{ms}$ , $T_j=25^\circ\text{C}$ )		880	
$I^2t$ value for fusing ( $t_p=10\text{ms}$ , $T_j=25^\circ\text{C}$ )	$I^2t$	3200	$\text{A}^2\text{s}$
Critical rate of rise of on-state current ( $I_G=2 \times I_{GT}$ , $f=100\text{Hz}$ , $T_j=125^\circ\text{C}$ )	$di/dt$	100	$\text{A}/\mu\text{s}$
Peak gate current ( $t_p=20\mu\text{s}$ , $T_j=125^\circ\text{C}$ )	$I_{GM}$	10	A
Average gate power dissipation ( $T_j=125^\circ\text{C}$ )	$P_{G(AV)}$	0.5	W

Peak gate power	$P_{GM}$	25	W
Peak pulse voltage ( $T_j=25^{\circ}C$ ; non-repetitive, off-state; FIG.7)	$V_{pp}$	1	kV

**ELECTRICAL CHARACTERISTICS**( $T_j=25^{\circ}C$  unless otherwise specified)

Symbol	Test Condition	Quadrant	Value		Unit
$I_{GT}$	$V_D=12V R_L=33\Omega$	I - II -III	MAX.	50	mA
$V_{GT}$		I - II -III	MAX.	1.3	V
$V_{GD}$	$V_D=V_{DRM} T_j=125^{\circ}C$ $R_L=3.3K\Omega$	I - II -III	MIN.	0.2	V
$I_L$	$I_G=1.2I_{GT}$	I -III	MAX.	80	mA
		II		120	
$I_H$	$I_T=1A$		MAX.	70	mA
$dV/dt$	$V_D=800V$ Gate Open $T_j=125^{\circ}C$		MIN.	2000	V/ $\mu s$
( $dI/dt$ ) <sub>c</sub>	( $dV/dt$ ) <sub>c</sub> =20V/ $\mu s$ $T_j=125^{\circ}C$		MIN.	25	A/ms
$t_{on}$	$I_G=80mA I_A=400mA I_R=40mA$ $T_j=25^{\circ}C$		TYP.	8	$\mu s$
$t_{off}$				60	

**STATIC CHARACTERISTICS**

Symbol	Parameter		Value(MAX.)	Unit
$V_{TM}$	$I_{TM}=120A t_p=380\mu s$	$T_j=25^{\circ}C$	1.9	V
$V_{TO}$	Threshold voltage	$T_j=125^{\circ}C$	0.71	V
$R_D$	Dynamic resistance	$T_j=125^{\circ}C$	23	m $\Omega$
$I_{DRM}$	$V_D=V_{DRM} V_R=V_{RRM}$	$T_j=25^{\circ}C$	15	$\mu A$
$I_{RRM}$		$T_j=125^{\circ}C$	10	mA

**THERMAL RESISTANCES**

Symbol	Parameter	Value	Unit
$R_{th(j-c)}$	junction to case (AC)	0.28	$^{\circ}C/W$
$R_{th(j-a)}$	junction to ambient (AC)	45	$^{\circ}C/W$

**ORDERING INFORMATION**

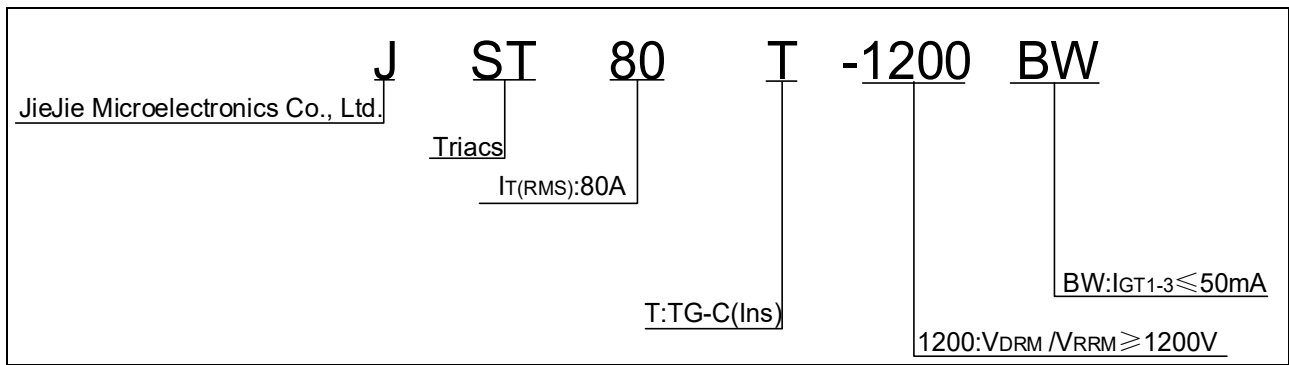

**MARKING**

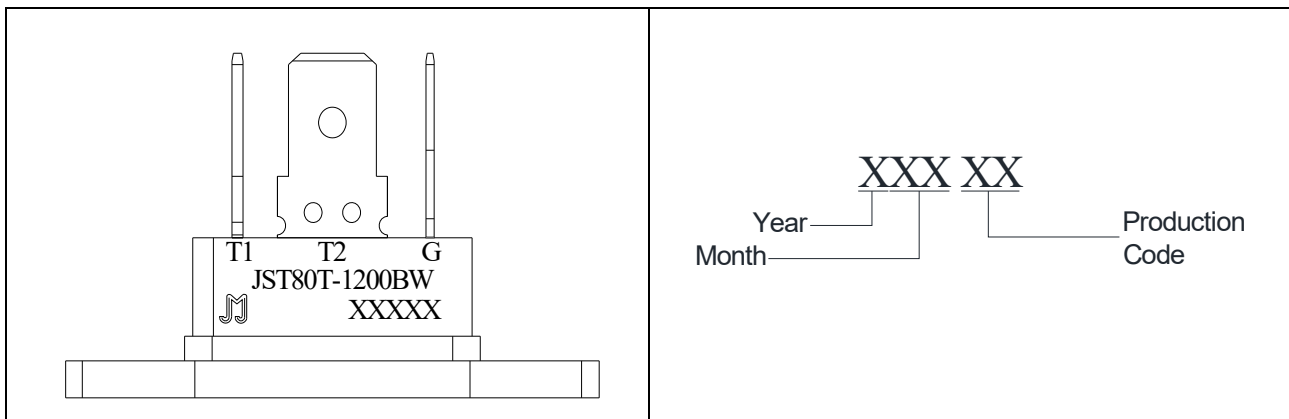

**FIG.1** Maximum power dissipation versus RMS on-state current

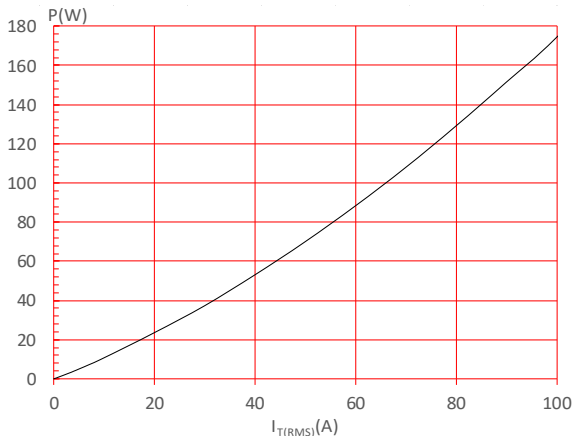

**FIG.3:** Surge peak on-state current versus number of cycles

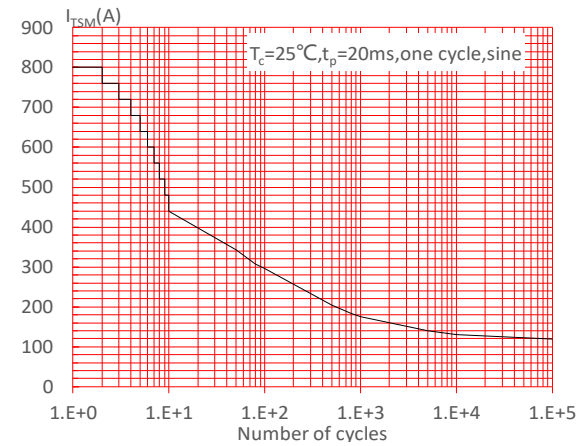

**FIG.5:** Non-repetitive surge peak on-state current for a sinusoidal pulse with width  $t_p < 20\text{ms}$ , and corresponding value of  $I^2t$  ( $di/dt < 100\text{A}/\mu\text{s}$ )

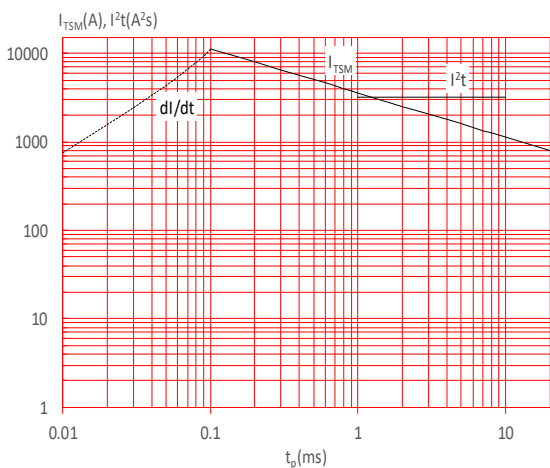

**FIG.2:** RMS on-state current versus case temperature

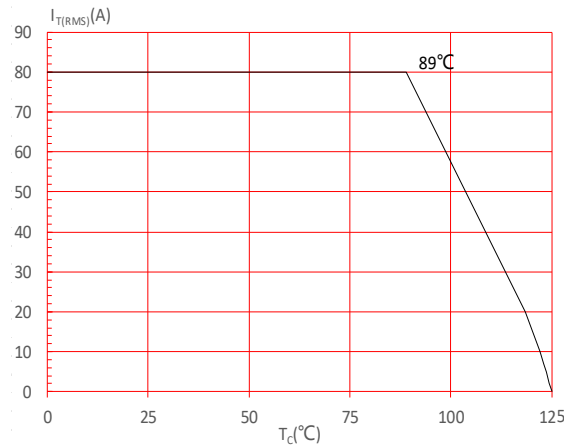

**FIG.4:** On-state characteristic

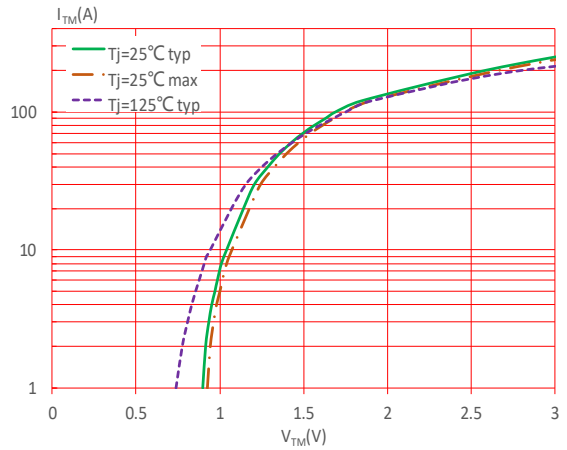

**FIG.6:** Relative variations of gate trigger current, holding current and latching current versus junction temperature

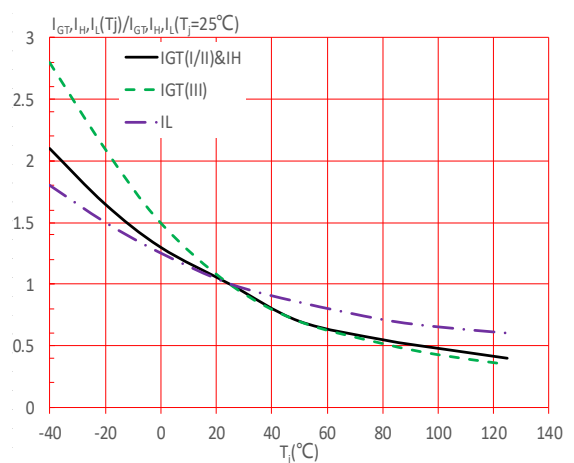
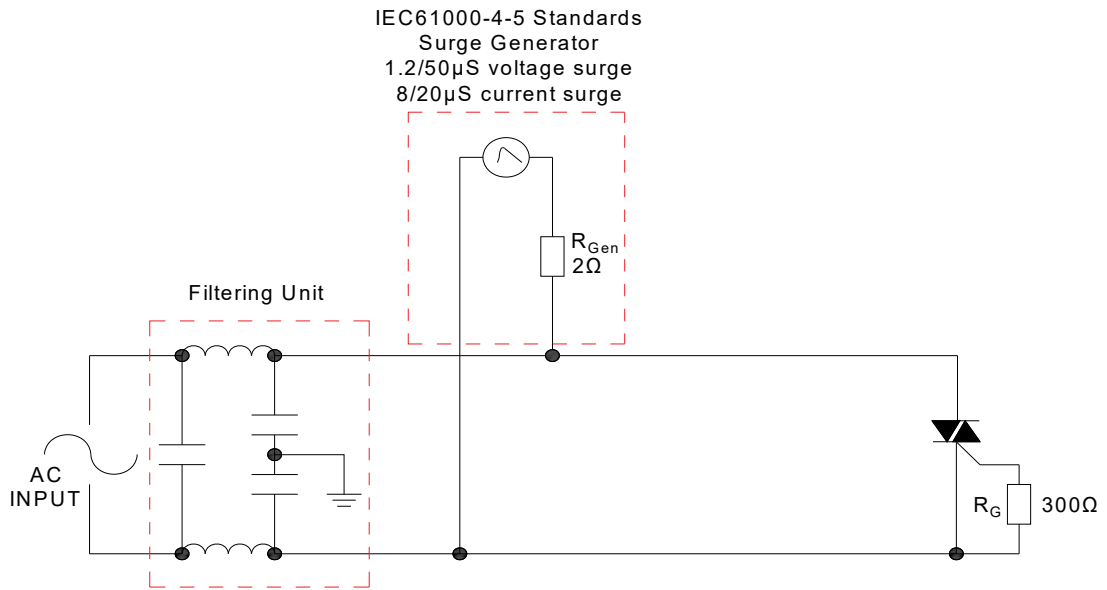

FIG.7: Test circuit for inductive and resistive loads to IEC-61000-4-5 standards



### SHAPING AND SOLDERING PARAMETERS

Refer to 《Instructions for installation of plastic-sealed in-line power devices》 released by JieJie

**ORDERING INFORMATION**

Order code	Voltage $V_{DRM}/V_{RRM}(V)$	IGT(mA)	Package	Base qty. (pcs)	Delivery mode
		I - II - III			
<b>JST80T-1200BW</b>	<b>1200</b>	<b>50</b>	<b>TG-C(Ins)</b>	<b>10</b>	<b>Tube</b>

**Document Revision History**

Date	Revision	Changes
Apr.11, 2023	A.1.0	Last updated

PACKAGE MECHANICAL DATA

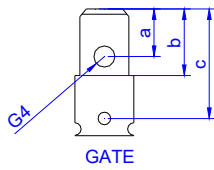
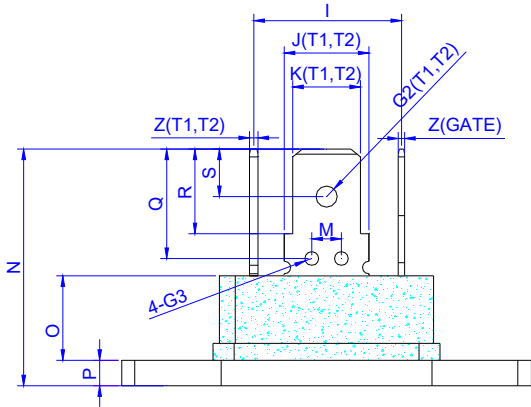
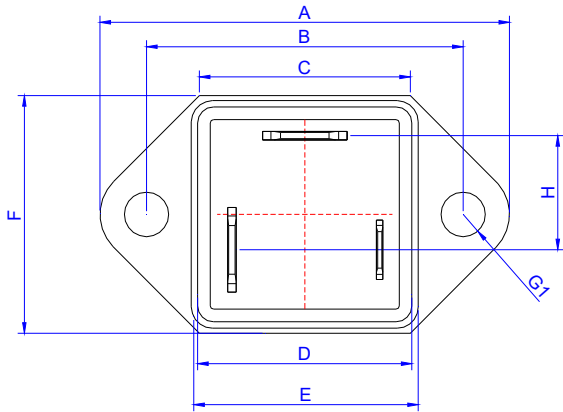

TG-C

Ref.	Dimensions					
	Millimeters			Inches		
	Min.	Typ.	Max.	Min.	Typ.	Max.
A			39.2			1.543
B	29.8	30.0	30.2	1.173	1.181	1.189
C			20.2			0.795
D			20.5			0.807
E			21.6			0.85
F			23			0.905
G1	Φ4.1	Φ4.2	Φ4.3	Φ0.161	Φ0.165	Φ0.169
H		10.3			0.406	
I		13.9			0.547	
J(T1,T2)		8			0.315	
K(T1,T2)		6.4			0.252	
M	2.7	3.0	3.3	0.106	0.118	0.130
N			22.8			0.898
O		8.2			0.323	
P		2.5			0.098	
Q	9.45	9.75	10.1	0.374	0.383	0.398
R	7.8	7.95	8.1	0.307	0.313	0.319
S	4.3	4.5	4.7	0.169	0.177	0.185
Z(T1,T2)	0.78	0.8	0.85	0.0307	0.0315	0.0335
G2(T1,T2)		Φ2	Φ2.2		Φ0.079	Φ0.087
G3	Φ1.1	Φ1.3	Φ1.5	Φ0.043	Φ0.051	Φ0.059
G4		Φ1.55	Φ1.75		Φ0.061	Φ0.069
a	2.95	3.15	3.35	0.116	0.124	0.132
b	6.2	6.35	6.5	0.244	0.25	0.256
c	9.35	9.75	10	0.368	0.384	0.393
Z(GATE)	0.58	0.6	0.65	0.0228	0.0236	0.0256
J(GATE)		5.6			0.221	
K(GATE)		4.65			0.183	

DELIVERY MODE

PACKAGE	OUTLINE	TUBE (PCS)	INNER BOX (PCS)	PER CARTON (PCS)
TG-C	TUBE	10	100	500

Information furnished in this document is believed to be accurate and reliable. However, Jiangsu JieJie Microelectronics Co., Ltd. assumes no responsibility for the consequences of use without consideration for such information nor use beyond it. Information mentioned in this document is subject to change without notice, apart from that when an agreement is signed, Jiangsu JieJie complies with the agreement.

Products and information provided in this document have no infringement of patents. Jiangsu JieJie assumes no responsibility for any infringement of other rights of third parties which may result from the use of such products and information. This document supersedes and replaces all information previously supplied.

 is a registered trademark of Jiangsu JieJie Microelectronics Co., Ltd.

Copyright ©2023 Jiangsu JieJie Microelectronics Co., Ltd. Printed All rights reserved.